

SmartVu 5MP Fisheye Camera 1.7mm Lens, including Built-in Microphone



SmartVu cameras provide excellent image quality for all levels of applications, allowing scenes to be monitored more effectively, and action to be taken quickly and efficiently. The SmartVu 5MP Fisheye Camera provides continuous 360-degree coverage of an area and the facility of digital pan, tilt and zoom of both live and playback images.

WHY SMARTVU?

- ✓ Compliance with the latest Secure by Design guidelines, offering complete immunity from cyber threats.
- ✓ Connect SmartVu cameras over Co-axial or Ethernet cables, offering a lower cost to upgrade legacy analogue video surveillance systems to high definition IP.
- ✓ Automatic discovery and channel allocation of SmartVu cameras by Uniplex recorders with automatic firewall and VLAN configuration for better cyber security.
- ✓ MultiMode™ recording; save up to 50% on storage required for recording.
- ✓ Advanced alarm handling with Uniplex NVRs.
- ✓ NetVu Connected Remote Alarm Reporting.
- ✓ Simple configuration and maintenance with the option of Cloud-based support, further reducing whole-life costs of ownership.
- ✓ NetVu PowerScripts™ for quick and easy integration and customised applications.

KEY FEATURES

- 5MP (2592 x 1944) resolution.
- 1.7mm fisheye lens.
- Digital pan, tilt and zoom of live and playback images using Enterprise Observer™ software.
- Digital preset video image positioning using Enterprise Observer™ software.
- Up to 16 simultaneous video streams supported.
- Activity Detection and Video Motion Detection (VMD) supported.
- Audio Functionality for systems integration, with built-in microphone.
- Power Over Ethernet (PoE) or 12V DC power supply for flexible installation.
- 10 metres (32 feet) range integral infrared illuminator for 24-hour operation both indoors and outdoors.
- IP66 Environmental rating for outdoor applications.



Technical Specification

Image Sensors	1/3" 5MP Sony 335 sensor
Active Pixels	2592 (H) x 1944 (V).
Effective Pixels	2592 x 1944 @ 20fps.
AGC	Automatic and Manual
Day / Night Operation	Automatic. True Day / Night with IR Cut Filter
WDR	dWDR.
Signal to Noise Ratio	> 55dB.
Minimum Illumination	Colour Mode 0.05 Lux (AGC on) B&W Mode 0 Lux (IR on).
Electronic Shutter	Automatic.
Light Compensation	BLC / HLC.
Audio Gain Control	Fixed, User Selectable
Compression	H.264 High/Main/Baseline Profile. JPEG/MPEG4 compatible (Up to 16 simultaneous streams).
IR Distance	10m (32').
Interface	One 10M / 100M Self-Adaption Ethernet Port, RJ-45.
Lens Operation	Fixed

Focal Length	1.7mm.
Alarm Reporting	NetVu Connected Remote Alarm Reporting. SNMP Remote Alarm Reporting.
Analytics	VMD and Activity Detection integrated with Activity Search.
Network Protocols	NetVu Connected Advanced Streaming, NetVu Connected Remote Codec, HTTP/HTTPS, TCP/IP, UDP/IP, RTSP/RTP Unicast and Multicast, Telnet/SSH, FTP, PoE, NTP, SNMP, Zeroconf, ModBus, AoE.

General Specifications and Warranty

Power	12V DC Terminal Input / PoE Class 3. 8W.
IP Rating	IP66
Operating Temperature	-30°C to 60°C (-22°F to 140°F).
Operating Humidity	0% to 90% (Non-condensing).
Approvals	UKCA and CE marked. Complies with part 15 of FCC CFR47. RoHS Compliant.
Product Dimensions	Ø = 160mm. H = 47mm.
Product Weight	0.45 kg.
Warranty	1 year, plus additional 1 year (registration required).

PART NUMBERING

SmartVu 5MP Fisheye 1.7mm Lens

SV-360/5000/1M7/I

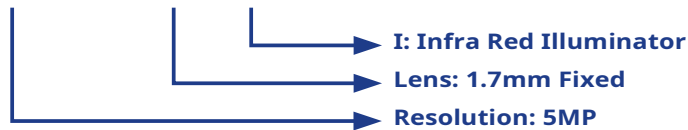

TECHNICAL DRAWING

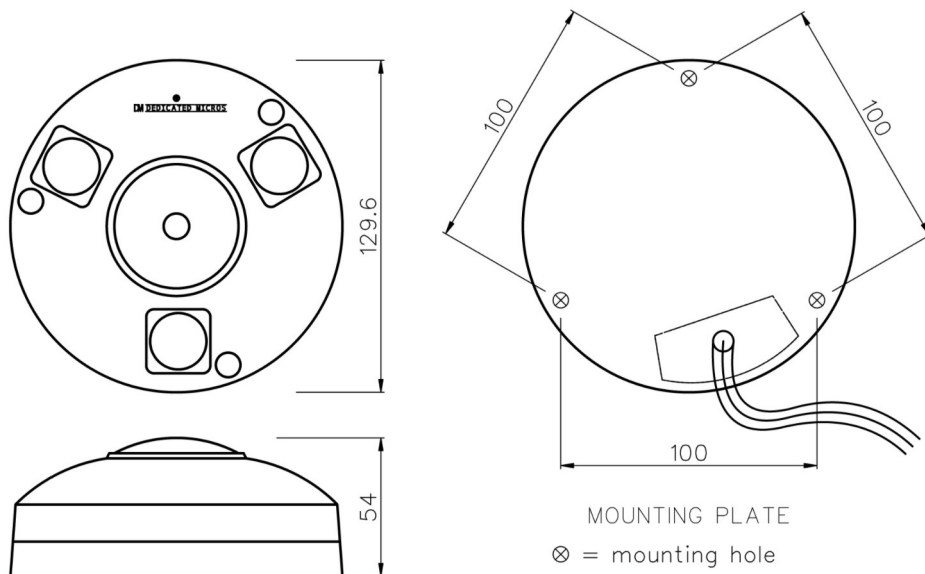

Version 1.4 © Copyright NetVu Limited. 10/03/2022. Design and specification subject to change without notice. E. and O.E.



Thellow Heath Park, Northwich Road, Northwich, Cheshire, CW9 6JB
 T: +44 (0) 1928 706 400 E: info@netvu.org.uk www.netvu.org.uk

